

FRONT.

SOFA. CANAPÉ. SOFÁ.



Designer
Mario Ruiz

STYLE. ESTILO.
Essential

VERSION. VERSIÓN.
Upholstered base. Base tapissée. Base tapizada.

FEATURES. TRAITS. CARACTERÍSTICAS.

The default back cushion is the standard option. Le coussin de dossier par défaut est l'option standard. El cojín de respaldo que se entrega por defecto es la opción standard.

Removable upholstery in the seat and back cushions.

Wooden frame covered with flexible cold shaped polyurethane foam and polyester fibre.

Suspension consisting of elasticated webbing in different tensions.

Seats in different polyurethane foam densities, with surface padding in fibre. Back cushions stuffed with polyester silicone fibre.

Headrests in polyurethane foam.

Three back cushions heights available: low (74 cm - 29.13 in), standard (81 cm - 31.89 in) or high (91 cm - 35.83 in)

LDPE bases.

Tapiserie déhoussable sur les coussins de l'assise et coussins du dossier.

Cadre en bois recouvert de mousse de polyuréthane souple à froid et de fibre de polyester.

Suspension au moyen de sangles élastiques entrelacées de différentes tensions.

Assise réalisé dans différentes densités de mousse polyuréthane, matelassé en surface avec du fibre. Coussins du dossier garnis de fibre de polyester silicone .

Repose-têtes fabriqués en mousse de polyuréthane.

Trois hauteurs de coussin pour les dossiers disponibles: BAS (74 cm), standard (81 cm) ou haut (91 cm)

Pieds en PEBD.

Tapicería desenfundable en cojines de asiento y cojines de respaldo.

Bastidor de madera recubierto de espuma de poliuretano flexible en frío y fibra de poliéster.

Suspensión mediante cinchas elásticas entrelazadas de diferentes tensiones.

Asientos realizados en distintas densidades de espuma de poliuretano, acolchados en la superficie con fibra. Cojines de respaldo rellenos de fibra de poliéster siliconada.

Reposacabezas en espuma de poliuretano.

Tres alturas de respaldo disponibles: bajo (74cm), estándar (81 cm) o alto (91 cm).

Pies en LDPE.

FRONT.

GENERAL MEASUREMENTS. MESURES GÉNÉRALES. MEDIDAS GENERALES.

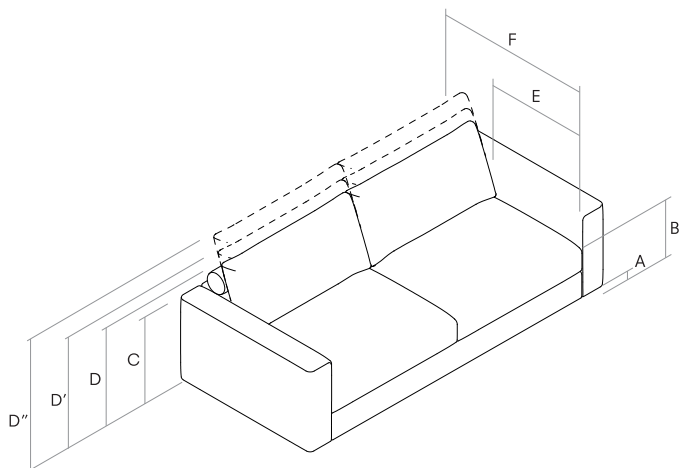

- A.** Base height. Hauteur du pied. Altura de la pata. 4 cm - 1.57"
- B.** Seat height. Hauteur du siège. Altura de asiento. 42 cm - 16.54"
- C.** Arm height. Hauteur des bras. Altura de brazo. 55 cm - 21.65"
- D.** Backrest height. Hauteur du dossier. Altura de respaldo. 74 cm - 29.13"
- D'.** Backrest height. Hauteur du dossier. Altura de respaldo. 81 cm - 31.89"
- D''.** Backrest height. Hauteur du dossier. Altura de respaldo. 91 cm - 35.83"
- E.** Seat depth. Profondeur d'assise. Profundidad de asiento. 56 cm - 22.05"
- F.** Depth. Profondeur. Profundidad. 96 cm - 37.80"

FINISHES. TRAITS. ACABADOS.

Finishes for the LDPE bases. Finitions des pieds PEBD. Acabados de las patas LDPE.

Low density polyethylene. Polyéthylène basse densité. Polietileno de baja densidad.



LDPE
PEBD

OPTIONAL BACK CUSHIONS. COUSSINS DU DOSSIER EN OPTION. COJINES DE RESPALDO OPCIONALES.

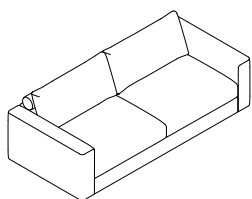

Low back cushion. Coussin de dossier bas. Respaldo bajo.
Backrest height. Hauteur du dossier. Altura de respaldo.
74 cm - 29.13"

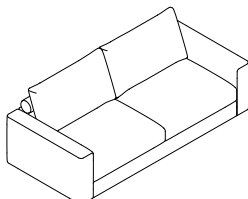

Standard back cushion. Coussin de dossier standard.
Respaldo estándar. Backrest height. Hauteur du dossier. Altura
de respaldo.
81 cm - 31.89"

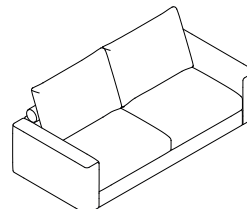

High back cushion. Coussin de dossier haut. Respaldo alto.
Backrest height. Hauteur du dossier. Altura de respaldo.
91 cm - 35.83"

FRONT.

DIMENSIONS. DIMENSIONES.

FRONT. Sofa. Canapé. Sofá.

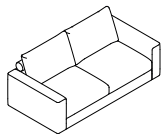

FROS194BT

194 x 96 H81
76.38" x 37.80" H31.89"

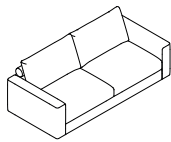

FROS214BT

214 x 96 H81
84.25" x 37.80" H31.89"

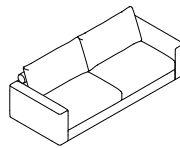

FROS234BT

234 x 96 H81
92.13" x 37.80" H31.89"

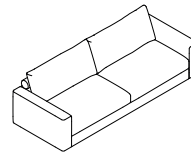

FROS254BT

254 x 96 H81
100" x 37.80" H31.89"

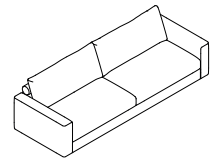

FROS274BT

274 x 96 H81
107.87" x 37.80" H31.89"

FRONT. Sofa with 1 arm. Canapé avec 1 accoudoir. Sofá con 1 brazo.

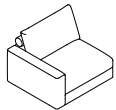

FROSI107BT

107 x 96 H81
42.13" x 37.80" H31.89"
IZQ.

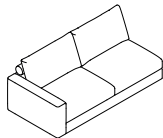

FROSI195BT

195 x 96 H81
76.77" x 37.80" H31.89"
IZQ.

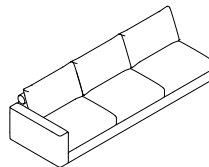

FROSI284BT

284 x 96 H81
111.81" x 37.80" H31.89"
IZQ.

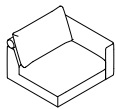

FROSD107BT

107 x 96 H81
42.13" x 37.80" H31.89"
DER.

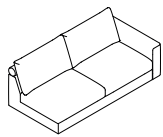

FROSD195BT

195 x 96 H81
76.77" x 37.80" H31.89"
DER.

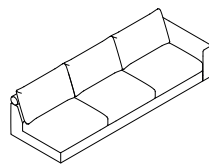

FROSD284BT

284 x 96 H81
111.81" x 37.80" H31.89"
DER.

FRONT.

DIMENSIONS. DIMENSIONES.

FRONT. Sofas without arms. Canapés sans accoudoirs. Sofás sin brazos.

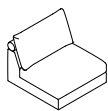

FROS090BT

90 x 96 H81
35.43"x 37.80" H31.89"

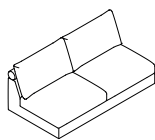

FROS0179BT

179 x 96 H81
70.47"x 37.80" H31.89"

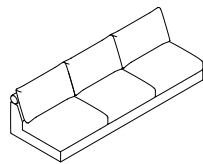

FROS0268BT

268 x 96 H81
105.51"x 37.80" H31.89"

FRONT. Chaise longue.

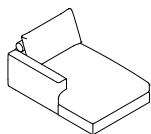

FROCLI107BT

107 x 170 H81
42.13"x 66.93" H31.89"
IZQ.

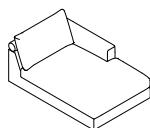

FROCLD107BT

107 x 170 H81
42.13"x 66.93" H31.89"
DER.

FRONT.

DIMENSIONS. DIMENSIONES.

FRONT. Corner. Angle. Rincón.

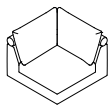

FROR94BT

94 x 94 H81
37.01"x 37.01" H31.89"

Single corner.
Angle uni.
Rincón Simple

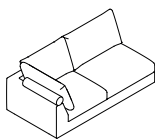

FRORI183BT

183 x 96 H81
72.05"x 37.80" H31.89"
IZQ.

Double corner.
Angle double.
Rincón doble.

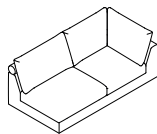

FRORD183BT

183 x 96 H81
72.05"x 37.80" H31.89"
DER.

Double corner.
Angle double.
Rincón doble.

FRONT. Open corner. Angle ouvert. Rincón abierto.

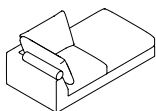

FRORI187BT

187 x 96 H81
73.62"x 37.80" H31.89"
IZQ.

Left corner, right ottoman.
Angle gauche, pouf droit.
Rincón izquierdo, ottoman derecho.

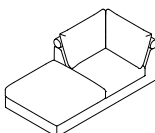

FRORD187BT

187 x 96 H81
73.62"x 37.80" H31.89"
DER.

Right corner, left ottoman.
Angle droit, pouf gauche.
Rincón derecho, ottoman izquierdo.

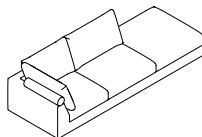

FRORI277BT

277 x 96 H81
109.06"x 37.80" H31.89"
IZQ.

Left corner, right ottoman.
Angle gauche, pouf droit.
Rincón izquierdo, ottoman derecho.

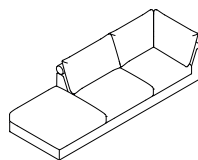

FRORD277BT

277 x 96 H81
109.06"x 37.80" H31.89"
DER.

Right corner, left ottoman.
Angle droit, pouf gauche.
Rincón derecho, ottoman izquierdo.

FRONT. Sofa corners. Canapés angle. Sofás rincón.

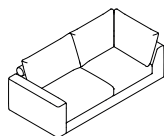

FROSIRD200BT

200 x 96 H81
78.74"x 37.80" H31.89"
IZQ.

Left arm, right corner.
Accoudoir gauche, angle droit.
Brazo izquierdo, rincón derecho.

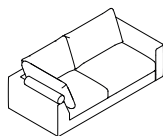

FROSDRI200BT

200 x 96 H81
78.74"x 37.80" H31.89"
DER.

Right arm, left corner.
Accoudoir droit, angle gauche.
Brazo derecho, rincón izquierdo.

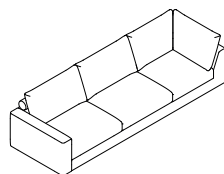

FROSIRD289BT

289 x 96 H81
113.78"x 37.80" H31.89"
IZQ.

Left arm, right corner.
Accoudoir gauche, angle droit.
Brazo izquierdo, rincón derecho.

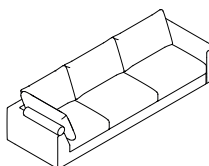

FROSDRI289BT

289 x 96 H81
113.78"x 37.80" H31.89"
DER.

Right arm, left corner.
Accoudoir droit, angle gauche.
Brazo derecho, rincón izquierdo.

FRONT.

DIMENSIONS. DIMENSIONES.

FRONT. Ottomans. Poufs. Ottomans.

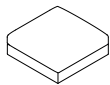

FROPC96X96BT

96 x 96 H42
37.80"x 37.80" H16.54"

Corner Ottoman. To be placed acting as a corner element.

Pouf angle. A placer comme élément d'angle.

Ottoman rincón. Para colocar actuando como elemento de esquina.

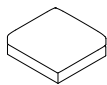

FROPT96X96BT

96 x 96 H42
37.80"x 37.80" H16.54"

Terminal ottoman. To be placed at the end of a composition.

Pouf terminal. A placer à la fin d'une composition.

Ottoman terminal. Para colocar al final de una composición.

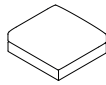

FROPI91X96BT

91 x 96 H42
35.83"x 37.80" H16.54"

Interleaved ottoman. To be placed between modules on a composition.

Pouf intercalé. A placer entre les modules d'une composition.

Ottoman intercalado. Para ser colocado entre módulos de una composición.

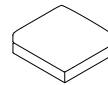

FROPE96X96BT

96 x 96 H42
37.80"x 37.80" H16.54"

Exempt ottoman. Works individually.

Pouf exonéré. Fonctionne individuellement.

Ottoman exento. Funciona individualmente.