

SINGULAR.  
EMBRACING.  
**FLOW.**

JOQUER

FLOW COLLECTION.

JOQUER

# JOQUER IS AN ARTISANAL AND METICULOUS COMPANY THAT HAS BEEN MANUFACTURING UPHOLSTERED FURNITURE FOR FORTY YEARS.



Our essence lies in the patient crafting of high-quality products, offering personalized solutions to our clients through complete control of the manufacturing process. For us, every space is unique, and every person is different. That's why the design of all our collections, both indoor and outdoor, is tailored to respond to four distinct lifestyles: Essential, Cozy, Singular, and New Classic. The distinctive character of each is, at the same time, united under a single design

philosophy, making all our products exude an unmistakable aesthetic serenity. Our furniture comes to life through three core values: accessible luxury, a valuable piece for everyday use, and timeless design. These three values feed off one another, each being the natural consequence of the other two. Details, comfort, and materiality truly matter to us. That's why our motto is "The unique everyday," the ability to enjoy the everyday as something exceptional.

Joquer est une entreprise artisanale et méticuleuse qui fabrique des meubles rembourrés depuis quarante ans.

Notre essence réside dans l'élaboration patiente de produits de haute qualité, offrant des solutions personnalisées à nos clients grâce à un contrôle total du processus de fabrication.

Pour nous, chaque espace est unique et chaque personne est différente. C'est pourquoi le design de toutes nos collections, tant intérieures qu'extérieures, est conçu pour répondre à quatre styles de vie distincts : Essential, Cozy, Singular et New Classic.

Le caractère distinctif de chacun est, en même temps, uni sous une seule philosophie de design, ce qui fait que tous nos produits dégagent une sérénité esthétique indéniable.

Nos meubles prennent vie à travers trois valeurs fondamentales : le luxe accessible, une pièce précieuse pour un usage quotidien, et un design intemporel. Ces trois valeurs se nourrissent mutuellement, chacune étant la conséquence naturelle des deux autres.

Les détails, le confort et la matérialité ont véritablement de l'importance pour nous. C'est pourquoi notre slogan est "Le quotidien unique", la capacité de profiter de l'ordinaire comme quelque chose d'exceptionnel.

Joquer es una empresa artesana y cuidadosa que lleva cuarenta años fabricando mobiliario tapizado. Nuestra esencia es la elaboración paciente de productos de mucha calidad, dando respuestas personalizadas a nuestros clientes desde un control total del proceso de fabricación.

Para nosotros, cada espacio es único y cada persona es diferente. Por eso, el diseño de todas nuestras colecciones, de interior y exterior, responde a cuatro estilos de vida: Essential, Cozy, Singular y New Classic.

El carácter diferenciador de cada uno está, al mismo tiempo, unido bajo una misma forma de entender el diseño, lo que hace que todos nuestros productos respiren una inconfundible serenidad estética.

Nuestros muebles se hacen realidad a partir de tres valores: ser un lujo accesible, ser una pieza valiosa para cada día y tener un diseño atemporal. Los tres se retroalimentan, cada uno es la consecuencia natural de los otros dos.

Los detalles, la comodidad y la materialidad nos importan de verdad. Por eso nuestro lema es "The unique everyday", el saber disfrutar de lo cotidiano como algo excepcional.



# FLOW COLLECTION.



CURVED, ORGANIC, AND SENSUAL, THE ESSENCE OF THE FLOW COLLECTION IS A LANGUAGE OF FLUID FORMS, WITH SOFAS THAT EMBRACE BOTH THE BODY AND SPACE, OFFERING WELL-BEING AND BEAUTY.



The curves promote harmony and a more pleasurable connection with interior architecture, creating highly versatile décor solutions. Flow enhances the features of any small interior and excels in larger spaces through larger systems with chaise-longue modules, end poufs, and more. Additionally, it includes an armchair and a collection of upholstered chairs and benches, enabling the creation of flexible and comfortable compositions throughout all areas of the home.

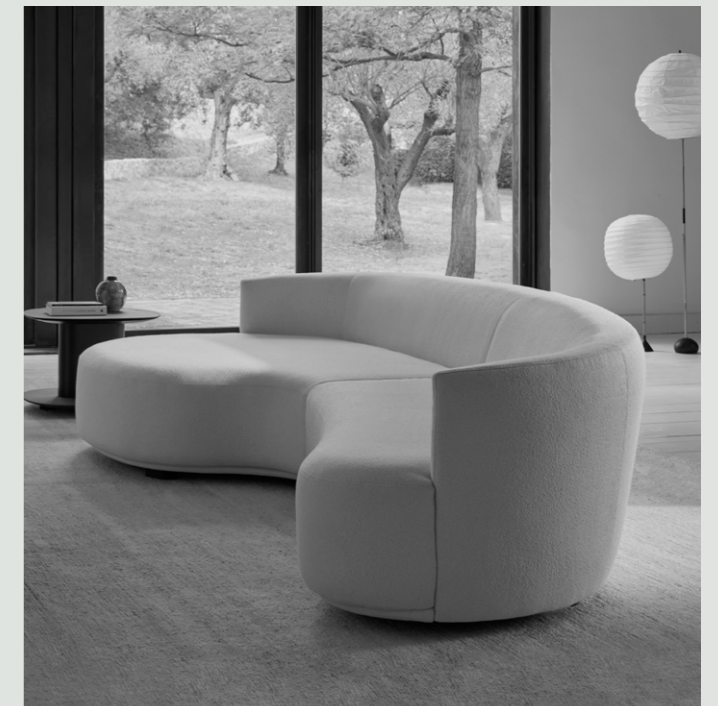



Courbée, organique et sensuelle, la collection Flow se nourrit d'un langage de formes fluides, avec des canapés qui étreignent le corps et l'espace, offrant bien-être et beauté. La courbe favorise l'harmonie et une connexion plus agréable avec l'architecture intérieure, permettant à cette collection de proposer des solutions décoratives très polyvalentes. Flow permet d'embellir les caractéristiques de tout intérieur de petite taille, tout en s'illustrant également dans les grands espaces grâce à des systèmes de plus grandes dimensions comprenant des modules de chaise-longue, des poufs finaux, etc. De plus, elle propose un fauteuil ainsi qu'une collection de chaises et de bancs rembourrés, permettant de créer des compositions flexibles et confortables dans tous les espaces de la maison.

Curvado, orgánico y sensual, el alimento de la colección Flow es un lenguaje de formas fluidas, con sofás que abrazan el cuerpo y el espacio con bienestar y belleza. La curva favorece la armonía y una conexión más placentera con la arquitectura interior, logrando con esta colección soluciones de decoración muy versátiles. Flow permite embellecer las características de cualquier interior de pocos metros y también de grandes espacios a través de sistemas de mayores dimensiones con módulos de chaise-longue, puf final, etc. Además, cuenta con una butaca y una colección de sillas y bancos tapizados con los que crear composiciones flexibles y confortables en todos los espacios de la casa.



# MARIO RUIZ. THE DESIGNER.



Design that is pristine and prosaic. This motif runs through the work of Spanish designer Mario Ruiz (Alicante, 1965), who has built a cosmopolitan career rooted in the vocation to create timeless designs. Every one of his projects, which comprise furniture, lighting and technology design and art direction, is exactly as it seems: objects whose clean, soft, coherent lines are an invitation for use. Intense work has gone into expressing their purpose and careful attention into their details. Among the over 50 awards he has garnered, the Spanish National Design Prize, Best of Neocon, Metropolis and Wallpaper Magazine awards stand out.

Un design épuré et familier. C'est le fil conducteur de l'oeuvre du designer Mario Ruiz (Alicante, 1965), qui a bâti sa carrière internationale sur la conception d'ouvrages qui perdurent dans le temps. Chacun de ses projets, englobant la conception de meubles, d'éclairage et de solutions technologiques et artistiques est fidèle à son apparence : des objets aux lignes épurées, douces et harmonieuses qui invitent à être utilisés. Un travail intense a été réalisé afin d'en dévoiler la finalité et un grand soin a été apporté aux détails. Tout au long de son parcours, il s'est vu décerné plus de 50 récompenses parmi lesquelles le National Design Award 2016 et les prix du Best of Neocon, Metropolis et Wallpaper Magazine.

El diseño claro y cotidiano. Este es el argumento que guía el trabajo del diseñador Mario Ruiz (Alicante, 1965), constructor de una trayectoria cosmopolita sembrada con la vocación de conseguir diseños que perduren en el tiempo. Cada uno de sus proyectos, que abarcan el diseño de mobiliario, iluminación, tecnología y la dirección de arte es lo que se ve: objetos que invitan a ser utilizados desde sus formas limpias y comprensibles. En ellos hay un trabajo intenso de resolver la identidad de cada uso y una cuidadosa atención por el detalle. Entre los más de 50 premios que ha recibido figuran el Premio Nacional de Diseño 2016, Best of Neocon, Metropolis y Wallpaper Magazine.

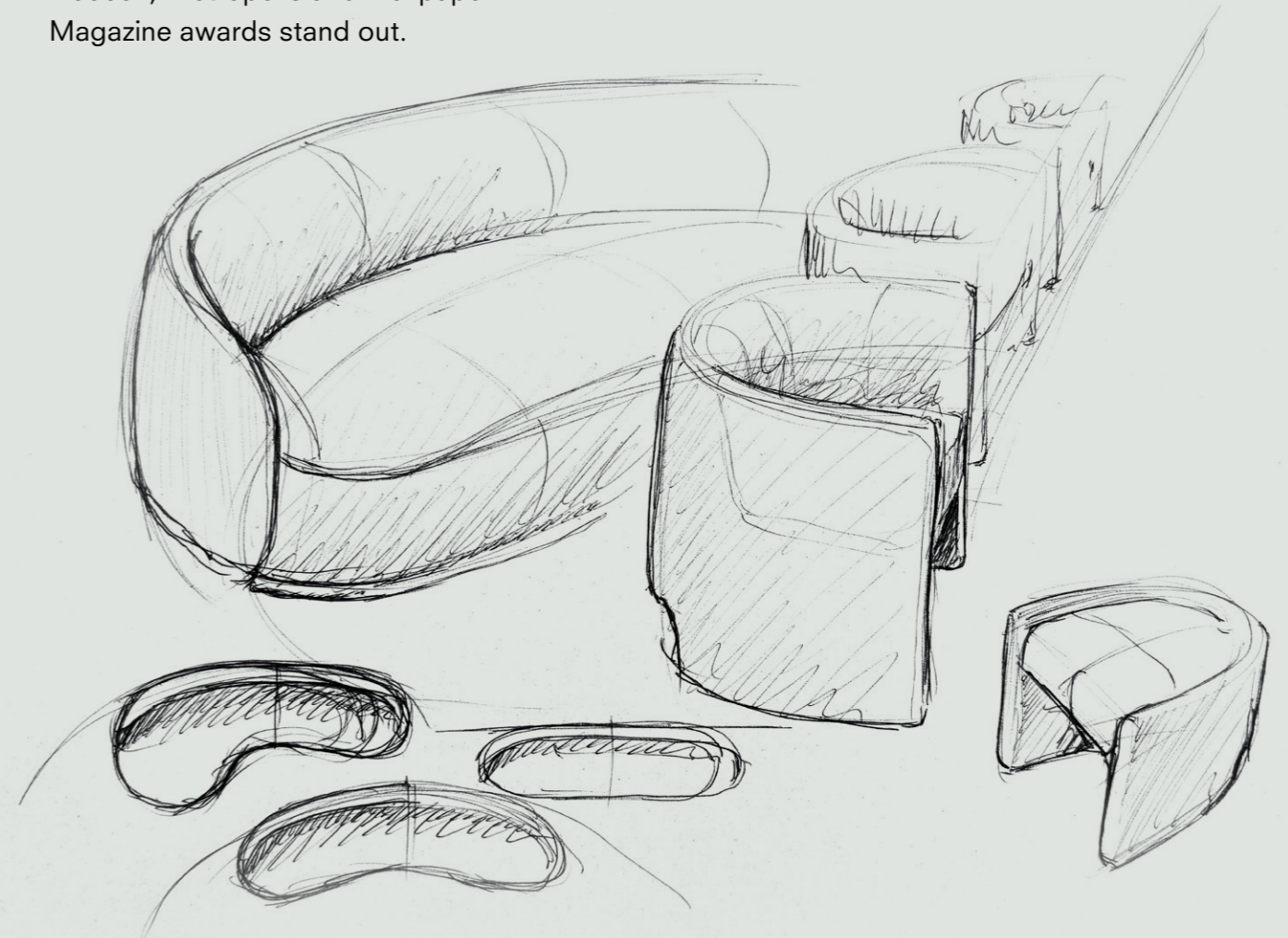



FLOCH60CB  
Fabric / Tissu / Tejido: Lexington 15



FLOB78  
Fabric / Tissu / Tejido: Jurga 04

SACSEC1, SACSET  
Technical stone / Pierre technique / Piedra técnica: Atalaia blanco.  
Wood / Bois / Madera: Dark stained oak, chêne teinte foncée, roble teñido oscuro.

FLOCLI155C, FLOSD155C  
Fabric / Tissu / Tejido: Yellowstone DEC 01

FLOCH60CB  
Fabric / Tissu / Tejido: Lexington 15





FLOCH60CB  
Fabric / Tissu / Tejido: Lexington 15



FLOB78  
Fabric / Tissu / Tejido: Clunis 779.006

SACSEC2  
Technical stone / Pierre technique / Piedra técnica: Geo gris.  
Wood / Bois / Madera: Dark stained oak, chêne teinte foncée, roble teñido oscuro.



FLOS228R  
Fabric / Tissu / Tejido: Yellowstone DEC 45

SACSEC2  
Technical stone / Pierre technique / Piedra técnica: Geo gris.  
Wood / Bois / Madera: Dark stained oak, chêne teinte foncée, roble teñido oscuro.

FLOB78  
Fabric / Tissu / Tejido: Clunis 779.006



FLOBA55  
Fabric / Tissu / Tejido: Clunis 779.006



ETHB86RBGC  
Fabric / Tissu / Tejido: Elmobaltique 33280

SACSEC1  
Technical stone / Pierre technique / Piedra técnica: Geo gris.  
Wood / Bois / Madera: Dark stained oak, chêne teinte foncée, roble teñido oscuro.

FLOSI155C, FLOSD155C  
Fabric / Tissu / Tejido: Yellowstone DEC 01



ETHB86RBGC  
Fabric / Tissu / Tejido: Elmobaltique 33280

FLOSI155C, FLOSD155C  
Fabric / Tissu / Tejido: Yellowstone DEC 01

SACSEC1  
Technical stone / Pierre technique /  
Piedra técnica: Geo gris.  
Wood / Bois / Madera: Dark stained oak,  
chêne teinté foncée, roble teñido oscuro.





FLOS228R  
Fabric / Tissu / Tejido: Yellowstone DEC 45

SACSEC1  
Wood / Bois / Madera: American walnut, noyer américain, nogal americano.



FLOB78  
Fabric / Tissu / Tejido: Sancho 03

FLOS228R  
Fabric / Tissu / Tejido: Yellowstone DEC 45

SACSEC1, SACSET  
Wood / Bois / Madera: American walnut, noyer américain, nogal americano.



FLOS228R  
Fabric / Tissu / Tejido: Yellowstone DEC 45

FLOB78  
Fabric / Tissu / Tejido: Sancho 03

SACSEC1, SACSET  
Wood / Bois / Madera: American walnut, noyer américain, nogal americano.



FLOS228C, FLODD228C  
Fabric / Tissu / Tejido: Clunis 779.002

SACSEC1, SACSET  
Wood / Bois / Madera: Dark stained oak, chêne teinte foncée, roble teñido oscuro.

FLOB78  
Fabric / Tissu / Tejido: Yellowstone DEC 41





FLOS228R  
Fabric / Tissu / Tejido:  
Yellowstone DEC 45

SERB74BSBAGC  
Fabric / Tissu / Tejido: Lario 17  
FLOS228C  
Fabric / Tissu / Tejido: Jurga 22  
SACSEC2  
Wood / Bois / Madera: Dark stained oak, chêne  
teinte foncée, roble teñido oscuro.

FLOB78  
Fabric / Tissu / Tejido: Jurga 08  
SACSET  
Wood / Bois / Madera: American walnut, noyer  
américain, nogal americano.



FLOBA122, FLOBA192  
Fabric / Tissu / Tejido: Elmobaltique 33280, Lario 09

Straight frame version.  
Version à structure droite.  
Versión de estructura recta.



Curved frame version.  
Version à structure courbe.  
Versión de estructura curva.

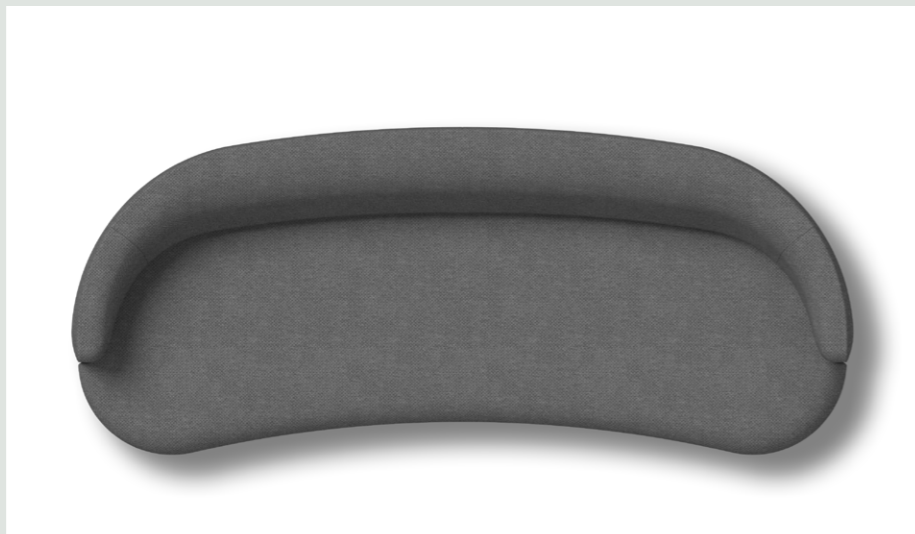

Stool. Tabouret. Taburete.  
(55 cm - 21.65")



Double bench. Banc double.  
Banco doble.  
(122 cm - 48.03")



Triple bench. Banc triple.  
Banco triple.  
(192 cm - 75.59")



**INFO.**

# TECHNICAL SPECIFICATIONS.

## INNER CONSTRUCTION CONSTRUCTION INTERIEURE CONSTRUCCIÓN INTERIOR

### FLOW SOFA SECTION. SECTION CANAPÉ FLOW. SECCIÓN SOFÁ FLOW.

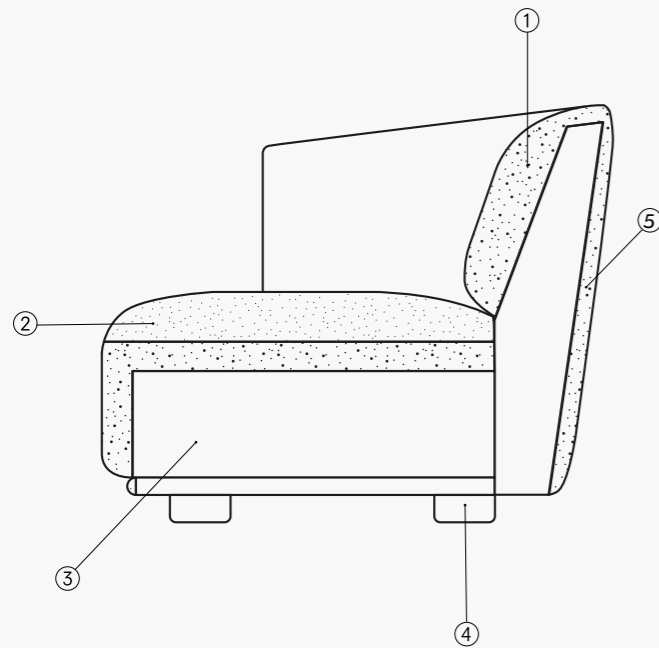

- ① Back in different polyurethane foam densities, with surface padding in polyester fibre.  
Dossier réalisé dans différentes densités de mousse polyuréthane, matelassé en surface avec du fibre de polyester.  
Respaldo realizado en distintas densidades de espuma de poliuretano, acolchado en la superficie con fibra de poliéster.
- ② Seat in different polyurethane foam densities with surface padding in polyester fibre.  
Assise réalisé dans différentes densités de mousse polyuréthane, matelassé en surface avec du fibre de polyester.  
Asiento realizado en distintas densidades de espuma de poliuretano, acolchado en la superficie con fibra de poliéster.
- ③ Wood frame.  
Châssis en bois.  
Bastidor de madera.
- ④ Solid beech wood feet.  
Pieds en bois de hêtre massif.  
Pies de madera de haya maciza.
- ⑤ Structure covered with flexible cold shaped polyurethane foam and polyester fibre.  
Structure recouvert de mousse de polyuréthane souple à froid et de fibre de polyester.  
Estructura recubierta de espuma de poliuretano flexible en frío y fibra de poliéster.

### FLOW ARMCHAIR, CHAIR, BENCH SECTION. SECTION FAUTEUIL, CHAISE, BANC FLOW. SECCIÓN BUTACA, SILLA, BANCO FLOW.

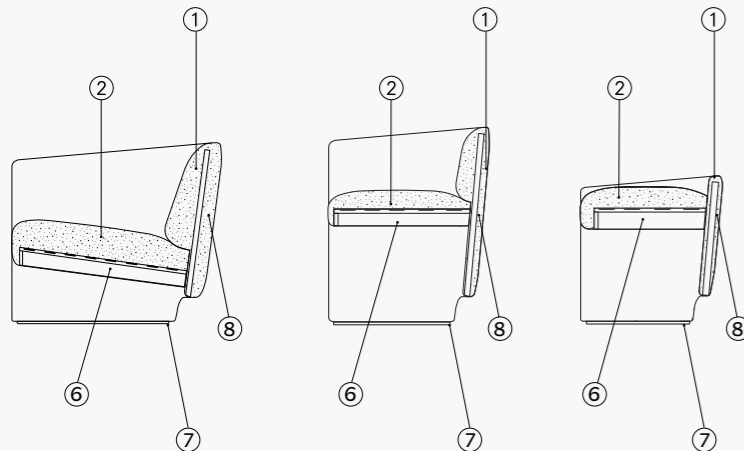

- ⑥ Wooden frame with elastic webbing suspension.  
Châssis en bois avec suspension de sangles élastiques.  
Bastidor de madera con suspensión de cinchas elásticas.
- ⑦ Metal base with felt stops.  
Base métallique avec patins en feutre.  
Base metálica con topes de fieltro.
- ⑧ Structure covered with flexible cold shaped polyurethane foam and polyester fibre.  
Structure recouvert de mousse de polyuréthane souple à froid et de fibre de polyester.  
Estructura recubierta de espuma de poliuretano flexible en frío y fibra de poliéster.

## FEATURES SOFA

- Fixed upholstery.
- Wooden frame covered with flexible cold shaped polyurethane foam and polyester fibre.
- Seat, back and arms in different polyurethane foam densities, with surface padding in fibre.
- Solid beech wood feet.

## ARMCHAIR. CHAIR. BENCH.

- Fixed upholstery.
- Wooden frame covered with flexible cold shaped polyurethane foam and polyester fibre.
- Suspension consisting of elasticated webbing in different tensions.
- Seat, back and arms in different polyurethane foam densities, with surface padding in fibre.
- Metal base with felt stops.

## TRAITS CANAPÉ

- Tapisserie fixe.
- Cadre en bois recouvert de mousse de polyuréthane souple à froid et de fibre de polyester.
- Assise, dossier et accoudoirs réalisés dans différentes densités de mousse polyuréthane, matelassés en surface avec du fibre.
- Pieds en bois de hêtre massif.

## FAUTEUIL. CHAISE. BANC.

- Tapisserie fixe.
- Cadre en bois recouvert de mousse de polyuréthane souple à froid et de fibre de polyester.
- Suspension au moyen de sangles élastiques entrelacées de différentes tensions.
- Assise, dossier et accoudoirs réalisés dans différentes densités de mousse polyuréthane, matelassés en surface avec du fibre.
- Base métallique avec patins en feutre.

## CARACTERÍSTICAS TÉCNICAS SOFÁ

- Tapisserie fija.
- Bastidor de madera recubierto de espuma de poliuretano flexible en frío y fibra de poliéster.
- Asiento, respaldos y brazos realizados en distintas densidades de espuma de poliuretano, acolchado en la superficie con fibra.
- Pies de madera de haya maciza.

## BUTACA. SILLA. BANCO.

- Tapisserie fija.
- Bastidor de madera recubierto de espuma de poliuretano flexible en frío y fibra de poliéster.
- Suspensión mediante cinchas elásticas entrelazadas de diferentes tensiones.
- Asiento, respaldos y brazos realizados en distintas densidades de espuma de poliuretano, acolchado en la superficie con fibra.
- Base metálica con topes de fieltro.

# DIMENSIONS. FLOW.

SOFA. CANAPÉ. SOFÁ.

Straight version. Version droite. Versión recta.

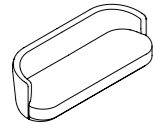

**FLOS228R**  
228 x 90 H70  
89.76" x 35.43" H27.56"

SOFA WITH 1 ARM. CANAPÉ AVEC 1 ACCOUDOIR. SOFÁ CON 1 BRAZO.

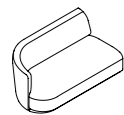

**FLOSI155R**  
155 x 90 H70  
61.02" x 35.43" H27.56"  
IZQ.

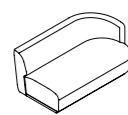

**FLOSD155R**  
155 x 90 H70  
61.02" x 35.43" H27.56"  
DER.

CHAISE LONGUE.

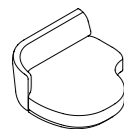

**FLOCLI155R**  
155 x 150 H70  
61.02" x 59.06" H27.56"  
IZQ.

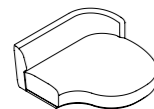

**FLOCLD155R**  
155 x 150 H70  
61.02" x 59.06" H27.56"  
DER.

DIVAN. DIVÁN.

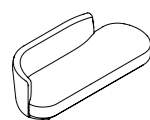

**FLODI228R**  
228 x 90 H70  
89.76" x 35.43" H27.56"  
IZQ.

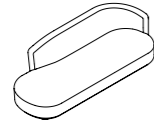

**FLODD228R**  
228 x 90 H70  
89.76" x 35.43" H27.56"  
DER.

SOFA. CANAPÉ. SOFÁ.

Curved version. Version courbe. Versión curva.

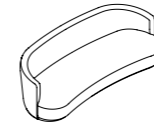

**FLOS228C**  
228 x 100 H70  
89.76" x 39.37" H27.56"

SOFA WITH 1 ARM. CANAPÉ AVEC 1 ACCOUDOIR. SOFÁ CON 1 BRAZO.



**FLOSI155C**  
155 x 115 H70  
61.02" x 45.28" H27.56"  
IZQ.

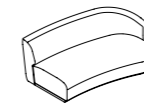

**FLOSD155C**  
155 x 115 H70  
61.02" x 45.28" H27.56"  
DER.

CHAISE LONGUE.



**FLOCLI155C**  
155 x 160 H70  
61.02" x 59.06" H27.56"  
IZQ.

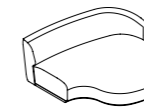

**FLOCLD155C**  
110 x 160 H70  
61.02" x 62.99" H27.56"  
DER.

DIVAN. DIVÁN.

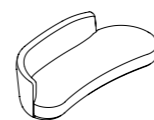

**FLODI228C**  
228 x 100 H70  
89.76" x 39.37" H27.56"  
IZQ.

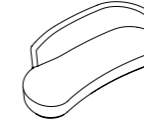

**FLODD228C**  
228 x 100 H70  
89.76" x 39.37" H27.56"  
DER.

ARMCHAIR. FAUTEUIL. BUTACA.

---



**FLOB78**  
78 x 78 H70  
30.71"x 30.71" H27.56"

CHAIR. CHAISE. SILLA.

---



**FLOCH60CB**  
60 x 60 H73  
23.62"x 23.62" H28.74"

BENCH. BANC. BANCO.

---



**FLOBA55**  
55 x 52 H55  
21.65"x 20.47" H21.65



**FLOBA122**  
122 x 52 H55  
48.03"x 20.47" H21.65

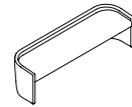

**FLOBA192**  
192 x 52 H55  
75.59"x 20.47" H21.65"

# SACHA SE.

COFFEE TABLE. TABLE BASSE. MESA BAJA.

---



**SACSEC1**  
140 x 140 H33  
55.12"x 55.12" H12.99"



**SACSEC2**  
140 x 85 H33  
55.12"x 33.46" H12.99"



**SACSEC3**  
180 x 85 H33  
70.87"x 33.46" H12.99"

SIDE TABLE. TABLE D'APPOINT. MESA AUXILIAR.

---



**SACSET**  
61.5 x 61.5 H42  
24.21"x 24.21" H16.54"

# HOME COLLECTION.

SINGULAR.



Flow straight by Mario Ruiz



Flow curved by Mario Ruiz



Serene curved by Mario Ruiz



Serene curved by Mario Ruiz



Sledd by Mario Ruiz



Serene by Mario Ruiz



Serene by Mario Ruiz



Senso by Mario Ruiz



Deck by Mario Ruiz



Daily by Mario Ruiz



Grey by Mario Ruiz



Flow by Mario Ruiz



Flow chair by Mario Ruiz



Flow by Mario Ruiz



Flow by Mario Ruiz



Flow by Mario Ruiz



Ethos by Mario Ruiz



Ethos by Mario Ruiz



Serene by Mario Ruiz



Serene chair by Mario Ruiz



Serene chair by Mario Ruiz

SINGULAR.



Senso by Mario Ruiz



Deck by Mario Ruiz



Grey by Mario Ruiz



Senso by Mario Ruiz



Senso by Mario Ruiz



Senso by Mario Ruiz



Serene by Mario Ruiz



Serene by Mario Ruiz



Axis curved square side table by Mario Ruiz



Axis curved rectangular side table by Mario Ruiz



Axis curved rectangular coffee table by Mario Ruiz



Axis curved square coffee table by Mario Ruiz



Axis side table by Mario Ruiz



Axis rectangular coffee table by Mario Ruiz



Axis square coffee table by Mario Ruiz



Serene desk by Mario Ruiz



Serene furniture by Mario Ruiz



COZY.



Silence by Mario Ruiz



Time by Mario Ruiz



Time by Mario Ruiz



Silence by Mario Ruiz



Silence by Mario Ruiz



Silence by Mario Ruiz



Silence by Mario Ruiz

NEW CLASSIC.



Magnus by Mario Ruiz



Magnus by Mario Ruiz



Venice by Mario Ruiz



Venice by Mario Ruiz



Magnus by Mario Ruiz



Magnus by Mario Ruiz



Venice by Mario Ruiz



Venice by Mario Ruiz



Venice sofa bed by Mario Ruiz



Venice by Mario Ruiz



Venice by Mario Ruiz



Venice by Mario Ruiz

ESSENTIAL.



Front by Mario Ruiz



Front by Mario Ruiz



Pulse by Mario Ruiz



Park



June



Code



Bouvier by Dario Gagliardini



Hat by Dario Gagliardini



Ivy by Mario Ruiz



Ivy by Mario Ruiz



Ivy by Mario Ruiz



Pulse by Mario Ruiz



Pulse by Mario Ruiz



Ivy sofa bed by Mario Ruiz



Suma H 40 cm by Mario Ruiz.



Suma H 40 cm by Mario Ruiz.



Mika tray by Mario Ruiz



Depart H 39 cm by Mario Ruiz.



Depart H 46 cm by Mario Ruiz



Depart SQ H 39 cm by Mario Ruiz



Pulse furniture by Mario Ruiz



Padi coffee table H 30 cm  
by Mario Ruiz



Padi coffee table H 36 cm  
by Mario Ruiz



Padi coffee table H 42 cm  
by Mario Ruiz



Tab round and square coffee tables  
H 46,5 cm by Mario Ruiz



Tab rectangular coffee tables  
H 46,5 cm by Mario Ruiz



Tab occasional tables H 55,6 cm  
by Mario Ruiz



Tab task tables H 55,6 cm  
by Mario Ruiz



Tab task table H 50,8 cm  
by Mario Ruiz



Tab work tables H 66,1 cm  
by Mario Ruiz



Sacha SE side table  
by Mario Ruiz



Sacha SE rectangular coffee tables  
by Mario Ruiz



Sacha SE square coffee table  
by Mario Ruiz



Sacha SQ side table  
by Mario Ruiz



Sacha SQ rectangular coffee table  
by Mario Ruiz



Sacha SQ square coffee table  
by Mario Ruiz



Mika bedside table  
by Mario Ruiz

# OUTDOOR COLLECTION.

SINGULAR.



Sledd Outdoor by Mario Ruiz



Sledd Outdoor by Mario Ruiz



Serene Outdoor by Mario Ruiz



Serene Outdoor by Mario Ruiz



Bene side table H 30 cm  
by Mario Ruiz



Bene side table H 42 cm  
by Mario Ruiz



Bene rectangular coffee table  
by Mario Ruiz



Bene square coffee table  
by Mario Ruiz



Axis Outdoor side table H 30 cm  
by Mario Ruiz



Axis Outdoor side table H 42 cm  
by Mario Ruiz



Axis Outdoor rectangular coffee table  
by Mario Ruiz



Axis Outdoor square coffee table  
by Mario Ruiz

COZY.



Silence Outdoor by Mario Ruiz



Silence Outdoor by Mario Ruiz

# CONTRACT COLLECTION.

SYSTEMS. SYSTÈMES. SISTEMAS MODULARES.



Flow straight system by Mario Ruiz



Flow curved system by Mario Ruiz



Serene curved system by Mario Ruiz



Serene curved system by Mario Ruiz



Daily Contract system by Mario Ruiz



Deck Contract system by Mario Ruiz



Depart system by Mario Ruiz



Summ system by Mario Ruiz



Depart power modules by Mario Ruiz

SOFAS. CANAPÉS. SOFÁS.

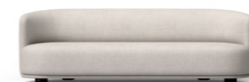

Flow straight by Mario Ruiz



Flow curved by Mario Ruiz



Serene curved by Mario Ruiz



Serene curved by Mario Ruiz



Daily Contract by Mario Ruiz



Deck Contract by Mario Ruiz



Summ by Mario Ruiz



Depart by Mario Ruiz



Depart Screen by Mario Ruiz



Grey Contract by Mario Ruiz



Serene Screen by Mario Ruiz



Venice Contract by Mario Ruiz



Flow by Mario Ruiz



Flow chair by Mario Ruiz



Bouvier by Dario Gagliardini



Deck by Mario Ruiz



Deck Contract by Mario Ruiz



Depart by Mario Ruiz



Grey by Mario Ruiz



Grey Contract by Mario Ruiz



Hat by Dario Gagliardini



Magnus by Mario Ruiz



Senso by Mario Ruiz



Serene by Mario Ruiz



Serene Screen by Mario Ruiz



Serene chair by Mario Ruiz



Time by Mario Ruiz



Venice by Mario Ruiz



Venice Contract by Mario Ruiz



Venice Contract by Mario Ruiz



Flow by Mario Ruiz



Flow by Mario Ruiz



Flow by Mario Ruiz



Suma H 40 cm by Mario Ruiz



Suma H 40 cm by Mario Ruiz



Mika tray by Mario Ruiz



Depart H 39 cm by Mario Ruiz



Depart H 46 cm by Mario Ruiz



Depart SQ H 39 cm by Mario Ruiz



Serene desk by Mario Ruiz



Serene furniture by Mario Ruiz



Pulse furniture by Mario Ruiz



Padi coffee table H 30 cm  
by Mario Ruiz



Padi coffee table H 36 cm  
by Mario Ruiz



Padi coffee table H 42 cm  
by Mario Ruiz



Tab round and square coffee tables  
H 46,5 cm by Mario Ruiz



Tab rectangular coffee tables  
H 46,5 cm by Mario Ruiz



Tab occasional tables H 55,6 cm  
by Mario Ruiz



Tab task tables H 55,6 cm  
by Mario Ruiz



Tab task table H 50,8 cm  
by Mario Ruiz



Tab work tables H 66,1 cm  
by Mario Ruiz



Sacha SE side table  
by Mario Ruiz



Sacha SE rectangular coffee tables  
by Mario Ruiz



Sacha SE square coffee table  
by Mario Ruiz



Sacha SQ side table  
by Mario Ruiz



Sacha SQ rectangular coffee table  
by Mario Ruiz



Sacha SQ square coffee table  
by Mario Ruiz



Axis side table  
by Mario Ruiz



Axis rectangular coffee table  
by Mario Ruiz



Axis square coffee table  
by Mario Ruiz



Axis curved rectangular side table  
by Mario Ruiz



Axis curved rectangular coffee table  
by Mario Ruiz



Axis curved square coffee table  
by Mario Ruiz



Axis curved square side table  
by Mario Ruiz



Mika bedside table  
by Mario Ruiz

Creative Direction  
Mario Ruiz

Concept, Art Direction & Graphic Design  
Studio Ainhoa Nagore

Photography  
Ángel Segura

Set Design  
Olivia Ricard/Slowkind

Special thanks to  
Alzeta Gallery  
DomésticoShop  
Cotlin

Printing  
Ce.Ge

Joquer Tapicerías S.A. reserves the right to change, without previous notice, materials, covers, finishes and drawings of the products presented in this catalogue. The textures and colours of materials and finishes are indicative as they are depending on the tolerances of the printing process.

Joquer Tapicerías, S.A. se réserve le droit de modifier sans préavis, les matériaux, tissus, finitions et dessins des produits représentés dans ce catalogue. Les textures et les couleurs des matériaux et des finitions sont présentés à titre indicatif et les teintes peuvent varier en fonction des techniques d'impression utilisées.

Joquer Tapicerías S.A. se reserva el derecho de modificar, sin previo aviso, materiales, tejidos, acabados y dibujos de los productos representados en este catálogo. Las texturas y colores de los materiales y acabados son indicativos dependiendo de las variaciones del proceso de impresión.

