

FRONT.

SOFA. CANAPÉ. SOFÁ.



Designer
Mario Ruiz

STYLE. ESTILO.
Essential

VERSION. VERSIÓN.
Suspended base. Base suspendue. Base suspendida.

FEATURES. TRAITS. CARACTERÍSTICAS.

The default back cushion is the standard option. Le coussin de dossier par défaut est l'option standard. El cojín de respaldo que se entrega por defecto es la opción standard.

Removable upholstery in the seat and back cushions.

Wooden frame covered with flexible cold shaped polyurethane foam and polyester fibre.

Seats in different polyurethane foam densities, with surface padding in fibre. Back cushions stuffed with polyester silicone fibre.

Headrests in polyurethane foam.

Three back cushions heights available: low (74 cm - 29.13 in), standard (81 cm - 31.89 in) or high (91 cm - 35.83 in).

Metal bases coated in polyester powder paint with a manganese topcoat and LDPE stops.

Tapiserie déhoussable sur les coussins de l'assise et coussins du dossier.

Cadre en bois recouvert de mousse de polyuréthane souple à froid et de fibre de polyester.

Assise réalisé dans différentes densités de mousse polyuréthane, matelassé en surface avec du fibre. Coussins du dossier garnis de fibre de polyester silicone .

Repose-têtes fabriqués en mousse de polyuréthane.

Trois hauteurs de coussin pour les dossiers disponibles: sous (74 cm), standard (81 cm) ou haut (91 cm).

Pieds métalliques recouverts en peinture polyester en poudre finition manganese avec butées en PEBD.

Tapicería desenfundable en cojines de asiento y cojines de respaldo.

Bastidor de madera recubierto de espuma de poliuretano flexible en frío y fibra de poliéster.

Asientos realizados en distintas densidades de espuma de poliuretano, acolchados en la superficie con fibra. Cojines de respaldo rellenos de fibra de poliéster siliconada.

Reposacabezas en espuma de poliuretano.

Tres alturas de respaldo disponibles: bajo (74cm), estándar (81 cm) o alto (91 cm).

Patas metálicas recubiertas en pintura poliéster en polvo acabado manganese con topes de LDPE.

FRONT.

GENERAL MEASUREMENTS. MESURES GÉNÉRALES. MEDIDAS GENERALES.

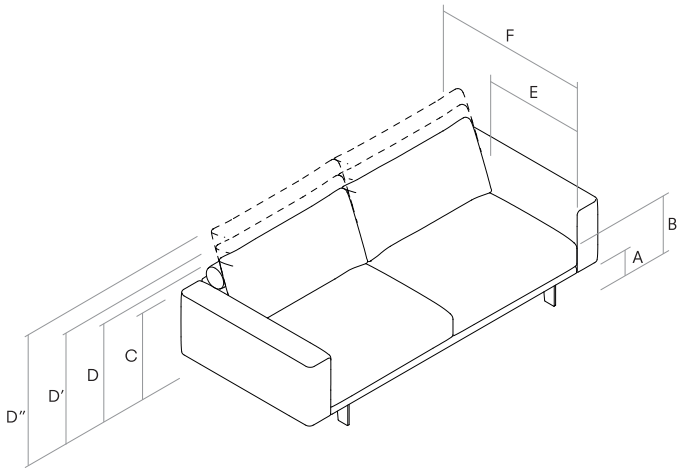

- A.** Base height. Hauteur du pied. Altura de la pata. 12 cm - 4.72"
- B.** Seat height. Hauteur du siège. Altura de asiento. 42 cm - 16.54"
- C.** Arm height. Hauteur des bras. Altura de brazo. 55 cm - 21.65"
- D.** Backrest height. Hauteur du dossier. Altura de respaldo. 74 cm - 29.13"
- D'.** Backrest height. Hauteur du dossier. Altura de respaldo. 81 cm - 31.89"
- D''.** Backrest height. Hauteur du dossier. Altura de respaldo. 91 cm - 35.83"
- E.** Seat depth. Profondeur d'assise. Profundidad de asiento. 56 cm - 22.05"
- F.** Depth. Profondeur. Profundidad. 96 cm - 37.80"

FINISHES. TRAITS. ACABADOS.

Finishes for the metal bases. Finitions des pieds métalliques. Acabados de las patas metálicas.

Polyester powder paint. Peinture polyester en poudre. Pintura poliéster en polvo.



Manganese metal.
Métal manganèse.
Metal manganeso.

OPTIONAL BACK CUSHIONS. COUSSINS DU DOSSIER EN OPTION. COJINES DE RESPALDO OPCIONALES.

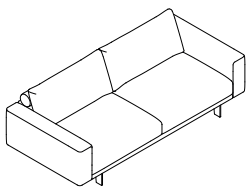

Low back cushion. Coussin de dossier bas. Respaldo bajo.
Backrest height. Hauteur du dossier. Altura de respaldo.
74 cm - 29.13"

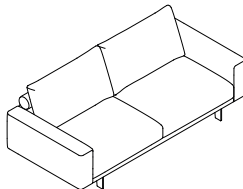

Standard back cushion. Coussin de dossier standard.
Respaldo estándar. Backrest height. Hauteur du dossier. Altura de respaldo.
81 cm - 31.89"

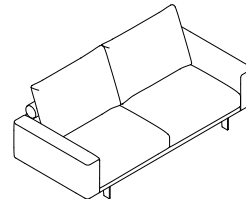

High back cushion. Coussin de dossier haut. Respaldo alto.
Backrest height. Hauteur du dossier. Altura de respaldo.
91 cm - 35.83"

FRONT.

DIMENSIONS. DIMENSIONES.

FRONT. Sofa. Canapé. Sofá.

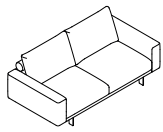

FROS194BS

194 x 96 H81
76.38"x 37.80" H31.89"

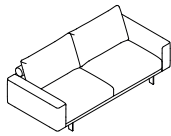

FROS214BS

214 x 96 H81
84.25"x 37.80" H31.89"

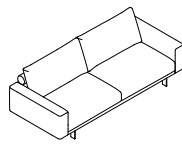

FROS234BS

234 x 96 H81
92.13"x 37.80" H31.89"

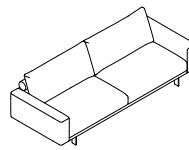

FROS254BS

254 x 96 H81
100"x 37.80" H31.89"

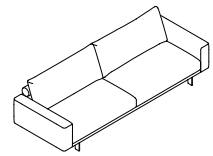

FROS274BS

274 x 96 H81
107.87"x 37.80" H31.89"

FRONT. Sofa with 1 arm. Canapé avec 1 accoudoir. Sofá con 1 brazo.

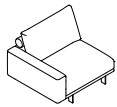

FROSI107BS

107 x 96 H81
42.13"x 37.80" H31.89"
IZQ.

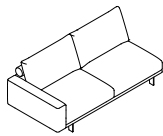

FROSI195BS

195 x 96 H81
76.77"x 37.80" H31.89"
IZQ.

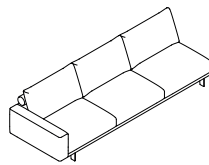

FROSI284BS

284 x 96 H81
111.81"x 37.80" H31.89"
IZQ.



FROSD107BS

107 x 96 H81
42.13"x 37.80" H31.89"
DER.

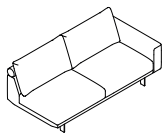

FROSD195BS

195 x 96 H81
76.77"x 37.80" H31.89"
DER.

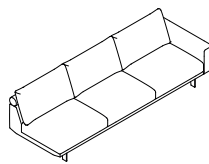

FROSD284BS

284 x 96 H81
111.81"x 37.80" H31.89"
DER.

FRONT.

DIMENSIONS. DIMENSIONES.

FRONT. Sofas without arms. Canapés sans accoudoirs. Sofás sin brazos.



FROS090BS

90 x 96 H81
35.43"x 37.80" H31.89"

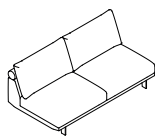

FROS0179BS

179 x 96 H81
70.47"x 37.80" H31.89"

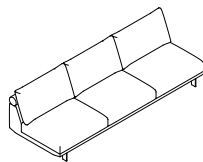

FROS0268BS

268 x 96 H81
105.51"x 37.80" H31.89"

FRONT. Chaise longue.

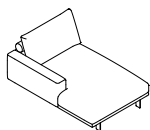

FROCLI107BS

107 x 170 H81
42.13"x 66.93" H31.89"
IZQ.

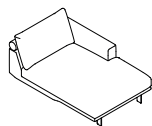

FROCLD107BS

107 x 170 H81
42.13"x 66.93" H31.89"
DER.

FRONT.

DIMENSIONS. DIMENSIONES.

FRONT. Corner. Angle. Rincón.

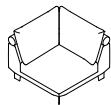

FROR94BS

94 x 94 H81
37.01"x 37.01" H31.89"

Single corner.
Angle uni.
Rincón Simple

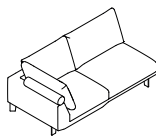

FRORI183BS

183 x 96 H81
72.05"x 37.80" H31.89"
IZQ.

Double corner.
Angle double.
Rincón doble.

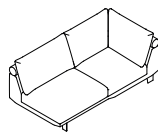

FRORD183BS

183 x 96 H81
72.05"x 37.80" H31.89"
DER.

Double corner.
Angle double.
Rincón doble.

FRONT. Open corner. Angle ouvert. Rincón abierto.

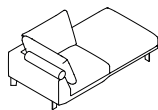

FRORI187BS

187 x 96 H81
73.62"x 37.80" H31.89"
IZQ.

Left corner, right ottoman.
Angle gauche, pouf droit.
Rincón izquierdo, ottoman derecho.

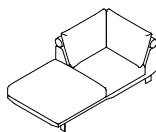

FRORD1187BS

187 x 96 H81
73.62"x 37.80" H31.89"
DER.

Right corner, left ottoman.
Angle droit, pouf gauche.
Rincón derecho, ottoman izquierdo.

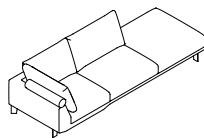

FRORI277BS

277 x 96 H81
109.06"x 37.80" H31.89"
IZQ.

Left corner, right ottoman.
Angle gauche, pouf droit.
Rincón izquierdo, ottoman derecho.

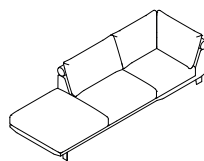

FRORD1277BS

277 x 96 H81
109.06"x 37.80" H31.89"
DER.

Right corner, left ottoman.
Angle droit, pouf gauche.
Rincón derecho, ottoman izquierdo.

FRONT. Sofa corners. Canapés angle. Sofás rincón.

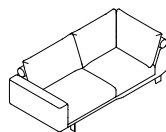

FROSIRD200BS

200 x 96 H81
78.74"x 37.80" H31.89"
IZQ.

Left arm, right corner.
Accoudoir gauche, angle droit.
Brazo izquierdo, rincón derecho.

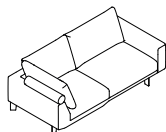

FROSDRI200BS

200 x 96 H81
78.74"x 37.80" H31.89"
DER.

Right arm, left corner.
Accoudoir droit, angle gauche.
Brazo derecho, rincón izquierdo.

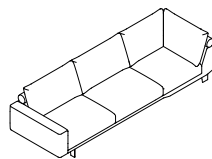

FROSIRD289BS

289 x 96 H81
113.78"x 37.80" H31.89"
IZQ.

Left arm, right corner.
Accoudoir gauche, angle droit.
Brazo izquierdo, rincón derecho.

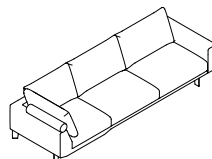

FROSDRI289BS

289 x 96 H81
113.78"x 37.80" H31.89"
DER.

Right arm, left corner.
Accoudoir droit, angle gauche.
Brazo derecho, rincón izquierdo.

FRONT.

DIMENSIONS. DIMENSIONES.

FRONT. Ottomans. Poufs. Ottomans.

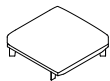

FROPC96X96BS

96 x 96 H42
37.80" x 37.80" H16.54"

Corner Ottoman. To be placed acting as a corner element.

Pouf angle. A placer comme élément d'angle.

Ottoman rincón. Para colocar actuando como elemento de esquina.

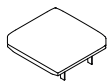

FROPT96X96BS

96 x 96 H42
37.80" x 37.80" H16.54"

Terminal ottoman. To be placed at the end of a composition.

Pouf terminal. A placer à la fin d'une composition.

Ottoman terminal. Para colocar al final de una composición.

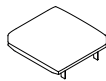

FROPI91X96BS

91 x 96 H42
35.83" x 37.80" H16.54"

Interleaved ottoman. To be placed between modules on a composition.

Pouf intercalé. A placer entre les modules d'une composition.

Ottoman intercalado. Para ser colocado entre módulos de una composición.

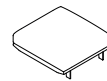

FROPE96X96BS

96 x 96 H42
37.80" x 37.80" H16.54"

Exempt ottoman. Works individually.

Pouf exonéré. Fonctionne individuellement.

Ottoman exento. Funciona individualmente.